



Designation: C1327 – 15

Standard Test Method for Vickers Indentation Hardness of Advanced Ceramics¹

This standard is issued under the fixed designation C1327; the number immediately following the designation indicates the year of original adoption or, in the case of revision, the year of last revision. A number in parentheses indicates the year of last reapproval. A superscript epsilon (ϵ) indicates an editorial change since the last revision or reapproval.

1. Scope

1.1 This test method covers the determination of the Vickers indentation hardness of advanced ceramics. In this test, a pointed, square base, pyramidal diamond indenter of prescribed shape is pressed into the surface of a ceramic with a predetermined force to produce a relatively small, permanent indentation. The surface projection of the two diagonals of the permanent indentation is measured using a light microscope. The average diagonal size and the applied force are used to calculate the Vickers hardness, which represents the material's resistance to penetration by the Vickers indenter. Hardness is computed as the ratio of the force to the contact surface area.

1.2 The values stated in SI units are to be regarded as standard. No other units of measurement are included in this standard.

1.3 *Units*—When Knoop and Vickers hardness tests were developed, the force levels were specified in units of grams-force (gf) and kilograms-force (kgf). This standard specifies the units of force and length in the International System of Units (SI); that is, force in newtons (N) and length in mm or μm . However, because of the historical precedent and continued common usage, force values in gf and kgf units are occasionally provided for information. This test method specifies that Vickers hardness be reported either in units of GPa, or a dimensionless Vickers hardness number that has implied units of kgf/mm^2 .

1.4 *This standard does not purport to address all of the safety concerns, if any, associated with its use. It is the responsibility of the user of this standard to establish appropriate safety and health practices and determine the applicability of regulatory limitations prior to use.*

2. Referenced Documents

2.1 ASTM Standards:²

- E4 Practices for Force Verification of Testing Machines
- E177 Practice for Use of the Terms Precision and Bias in ASTM Test Methods
- E384 Test Method for Microindentation Hardness of Materials
- E691 Practice for Conducting an Interlaboratory Study to Determine the Precision of a Test Method
- IEEE/ASTM SI 10 Standard for the Use of the International System of Units (SI): The Modern Metric System.

2.2 European Standard:

- CEN ENV 843-4 Advanced Technical Ceramics, Monolithic Ceramics, Mechanical Properties at Room Temperature, Part 4: Vickers, Knoop and Rockwell Superficial Hardness³

2.3 Japanese Standard:

- JIS R 1610 Testing Method for Vickers Hardness of High Performance Ceramics⁴

2.4 ISO Standard:

- ISO 6507/2 Metallic Materials—Hardness test—Vickers test—Part 2: HV0.2 to less than HV5⁵

3. Terminology

3.1 Definitions:

3.1.1 *Vickers hardness number (HV), n*—an expression of hardness obtained by dividing the force applied to a Vickers indenter by the surface area of the permanent impression made by the indenter.

² For referenced ASTM standards, visit the ASTM website, www.astm.org, or contact ASTM Customer Service at service@astm.org. For Annual Book of ASTM Standards volume information, refer to the standard's Document Summary page on the ASTM website.

³ Available from European Committee for Standardization (CEN), 36 rue de Stassart, B-1050, Brussels, Belgium, <http://www.cenorm.be>.

⁴ Available from Japanese Standards Organization (JSA), 4-1-24 Akasaka Minato-Ku, Tokyo, 107-8440, Japan, <http://www.jsa.or.jp>.

⁵ Available from International Organization for Standardization (ISO), 1, ch. de la Voie-Creuse, Case postale 56, CH-1211, Geneva 20, Switzerland, <http://www.iso.ch>.

¹ This test method is under the jurisdiction of ASTM Committee C28 on Advanced Ceramics and is the direct responsibility of Subcommittee C28.01 on Mechanical Properties and Performance.

Current edition approved Jan. 1, 2015. Published March 2015. Originally approved in 1996. Last previous edition approved in 2008 as C1327-08. DOI: 10.1520/C1327-15.

3.1.2 *Vickers indenter, n*—a square-based pyramidal-shaped diamond indenter with face angles of 136° 00'.

4. Summary of Test Method

4.1 This test method describes an indentation hardness test using a calibrated machine to force a pointed, square base, pyramidal diamond indenter having specified face angles, under a predetermined force, into the surface of the material under test and to measure the surface-projected diagonals of the resulting impression after removal of the force.

NOTE 1—A general description of the Vickers indentation hardness test is given in Test Method E384. The present method is very similar, has most of the same requirements, and differs only in areas required by the special nature of advanced ceramics. This test method also has many elements in common with standards ENV 843-4 and JIS R 1610, which are also for advanced ceramics.

5. Significance and Use

5.1 For advanced ceramics, Vickers indenters are used to create indentations whose surface-projected diagonals are measured with optical microscopes. The Vickers indenter creates a square impression from which two surface-projected diagonal lengths are measured. Vickers hardness is calculated from the ratio of the applied force to the area of contact of the four faces of the undeformed indenter. (In contrast, Knoop indenters are also used to measure hardness, but Knoop hardness is calculated from the ratio of the applied force to the projected area on the specimen surface.)

5.2 Vickers indentation hardness is one of many properties that is used to characterize advanced ceramics. Attempts have been made to relate Vickers indentation hardness to other hardness scales, but no generally accepted methods are available. Such conversions are limited in scope and should be used with caution, except for special cases where a valid basis for the conversion has been obtained by comparison tests.

5.3 Vickers indentation diagonal lengths are approximately 2.8 times shorter than the long diagonal of Knoop indentations, and the indentation depth is approximately 1.5 times deeper than Knoop indentations made at the same force.

5.4 Vickers indentations are influenced less by specimen surface flatness, parallelism, and surface finish than Knoop indentations, but these parameters must be considered nonetheless.

5.5 Vickers indentations are much more likely to cause cracks in advanced ceramics than Knoop indentations. The cracks may influence the measured hardness by fundamentally altering the deformation processes that contribute to the formation of an impression, and they may impair or preclude measurement of the diagonal lengths due to excessive damage at the indentation tips or sides.

5.6 A full hardness characterization includes measurements over a broad range of indentation forces. Vickers hardness of ceramics usually decreases with increasing indentation size or indentation force, as shown in Fig. 1. The trend is known as the indentation size effect (ISE). Hardness approaches a plateau constant hardness at sufficiently large indentation size or forces. The test forces or loads that are needed to achieve a

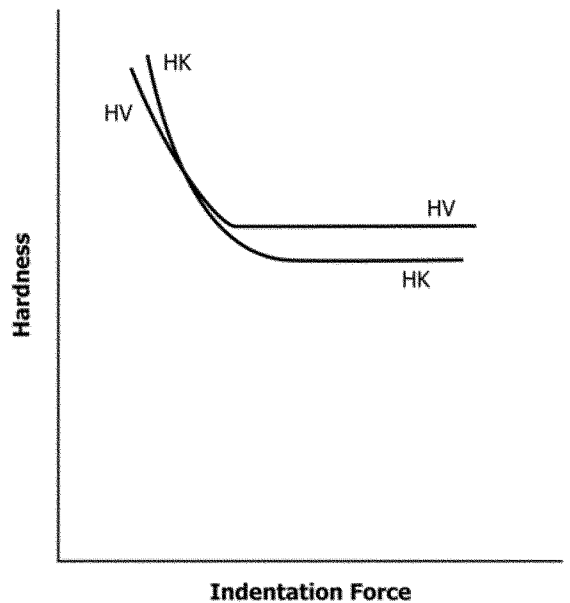

FIG. 1 Indentation Size Effect (ISE) Curves for a Ceramic (Sometimes they continuously approach a plateau hardness at larger forces, but sometimes they can have a shift or step if cracking occurs.)

constant hardness vary with the ceramic. The test force specified in this standard is intended to be sufficiently large that hardness is either close to or on the plateau, but not so large as to introduce excessive cracking. A comprehensive characterization of the ISE is recommended but is beyond the scope of this test method, which measures hardness at a single, designated force.

6. Interferences

6.1 Cracking from the indentation tips can interfere with determination of tip location and thus the diagonal length measurements.

6.2 Cracking or spalling around the Vickers impression may occur and alter the shape and clarity of the indentation, especially for coarse-grained ceramics whereby grains may cleave and dislodge. The cracking may occur in a time-dependent manner (minutes or hours) after the impression is made.

6.3 Porosity (either on or just below the surface) may interfere with measuring Vickers hardness, especially if the indentation falls directly onto a large pore or if the indentation tip falls in a pore.

6.4 At higher magnifications in the optical microscope, it may be difficult to obtain a sharp contrast between the indentation tip and the polished surface of some advanced ceramics. This may be overcome by careful adjustment of the lighting as discussed in Test Method E384.

7. Apparatus

7.1 Testing Machines:

7.1.1 There are three general types of machines available for conducting this test. One type is a self-contained unit built for this purpose that uses deadweights (masses) on a pan or lever

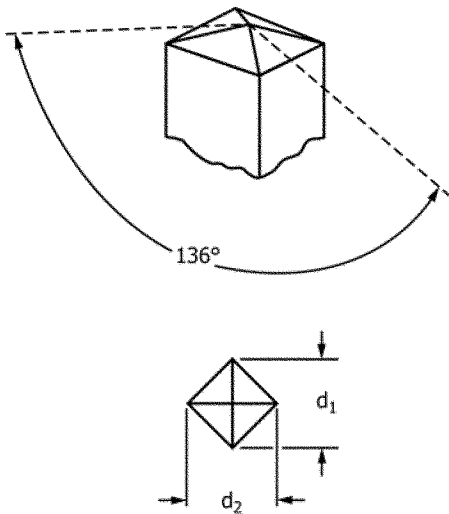

FIG. 2 Vickers Indenter

7.2.3 The diamond should be examined periodically; and if it is loose in the mounting material, chipped, or cracked, it shall be replaced.

NOTE 2—This requirement is from Test Method E384 and is especially pertinent to Vickers indenters used for advanced ceramics. Vickers indenters are often used at high loads in advanced ceramics in order to create cracks. Such usage can lead to indenter damage. The diamond indenter can be examined with a scanning electron microscope. Indenters may also be inspected with an optical microscope with at least 500x power, but care should be taken to avoid damaging the microscope lens. Indentations can be made into soft copper to help determine if a chip or crack is present. A visual inspection of the resulting indentation may be sufficient to verify the absence of defects from the shape of indentations performed on test blocks.

7.3 Measuring Microscope:

7.3.1 The measurement system shall be constructed so that the length of the diagonals can be determined with errors not exceeding ± 0.5 μm (±0.0005 mm).

NOTE 3—Stage micrometers with uncertainties less than this shall be used to establish calibration constants for the microscope. See Test Method E384, paragraph A1.3.3, Verification of the Indentation Measuring System. Ordinary stage micrometers that are used for determining the approximate magnification of photographs may be too coarsely ruled or may not have the required accuracy and precision.

7.3.2 The numerical aperture (NA) of the objective lens shall be between 0.60 and 0.90.

NOTE 4—The apparent length of a Vickers indentation increases as the resolving power and NA of a lens increases. However, the variation is much less than that observed in Knoop indentations (2, 5, 6). The range of NA specified by this test method corresponds to 40 to 100x objective lenses. The higher power lenses may have higher resolution, but the contrast between the indentation tips and the polished surface may be less. This numerical aperture requirement is similar to, but more specific than that in Test Method E384. The requirement is different because many white or grey ceramics are transparent or translucent, and tip imaging is more difficult.

7.3.3 A filter may be used to provide monochromatic illumination. Green filters have proved to be useful.

7.3.4 If indentation diagonal sizes are measured from digital images acquired from a digital camera, then follow the manufacturer's guidelines for use of the camera, the computer monitor, and the software. It is strongly recommended to use a calibrated stage micrometer to verify the precision and accuracy of the length measuring procedure. The camera pixel count, the monitor pixel count and resolution, and the length measuring software shall be such that the requirements of 7.3.1 can be met.

8. Test Specimens

8.1 The Vickers indentation hardness test is adaptable to a wide variety of advanced ceramic specimens. In general, the accuracy of the test will depend on the smoothness of the surface and, whenever possible, ground and polished specimens should be used. The back of the specimen shall be fixed so that the specimen cannot rock or shift during the test.

8.1.1 Thickness—As long as the specimen is over ten times as thick as the indentation depth, the test will not be affected. In general, if specimens are at least 0.50 mm thick, the hardness will not be affected by variations in the thickness.

8.1.2 Surface Finish—Specimens should have a ground and polished surface. The roughness should be less than 0.1 μm

beam to carefully apply force to the test piece. There is no load cell to record the force during the test sequence. The machine has a built-in compound optical microscope for measuring the indentation sizes. The second type is an accessory to existing compound optical microscopes. Usually, this second type is fitted on an inverted-stage microscope. The third, more modern type, is a self-contained unit built for this purpose which has a built-in load cell that controls a ratio of crosshead that moves the indenter into contact with the test piece. The peak force and rate of force application can be controlled by a closed-loop feedback circuit. The machine has a built-in compound optical microscope for measuring the indentation sizes. Descriptions of the various machines are available (1-3).

7.1.2 Design of the machine should be such that the force application rate, dwell time, and applied force can be set within the limits set forth in 10.5. It is an advantage to eliminate the human element whenever possible by appropriate machine design. The machine should be designed so that vibrations induced at the beginning of a test will be damped out by the time the indenter touches the sample.

7.1.3 The calibration of the balance beam or force application system should be checked monthly or as needed. Indentations in standard reference materials may also be used to check calibration when needed.

7.2 Indenter:

7.2.1 The indenter shall meet the specifications for Vickers indenters. See paragraph A1.3.5.1 of Test Method E384. The four edges formed by the four faces of the indenter shall be sharp. Chamfered edges (as in Ref (4)) are not permitted. The tip offset shall be not more than 0.5 μm in length.

7.2.2 Fig. 2 shows the indenter. The depth of the indentation is 1/8 the length of the diagonal. The indenter has an angle between opposite faces of 136° 0 min (±30 min).

6 The boldface numbers in parentheses refer to the list of references at the end of this test method.

rms. However, if one is investigating a surface coating or treatment, one cannot grind and polish the specimen.

NOTE 5—This requirement is necessary to ensure that the surface is flat and that the indentation is sharp. Residual stresses from polishing are of less concern for most advanced ceramics than for glasses or metals. References (7) and (8) report that surfaces prepared with 1 μm or finer diamond abrasive had no effect on measured ceramic hardness. Hardness was only affected when the surface finish had an optically resolvable amount of abrasive damage (7). (Extra caution may be appropriate during polishing of transformation toughening ceramics, such as some zirconias, since the effect upon hardness is not known.)

9. Preparation of Apparatus

9.1 Verification of Force—Most of the machines available for Vickers hardness testing use a loaded beam. This beam shall be tested for zero force. An indentation should not be visible with zero force, but the indenter should contact the sample. Methods of verifying the force application are given in Practices E4.

9.2 Separate Verification of Force, Indenter, and Measuring Microscope—Procedures in Test Method E384, Annex A1, Verification of Knoop and Vickers Hardness Testing Machines and Indenters, may be followed.

9.3 Verification by Standard Reference Materials—Standard reference blocks, SRM No. 2831, of tungsten carbide that are available from the National Institute of Standards and Technology⁷ can be used to verify that an apparatus produces a Vickers hardness within $\pm 5\%$ of the certified value.

10. Procedure

10.1 Specimen Placement—Place the specimen on the stage of the machine so that the specimen will not rock or shift during the measurement. The specimen surface shall be clean and free of any grease or film.

10.2 Specimen Leveling:

10.2.1 The surface of the specimen being tested shall lie in a plane normal to the axis of the indenter. The angle of the indenter and specimen surface should be within 2° of perpendicular.

NOTE 6—Greater amounts of tilting produce nonuniform indentations and invalid test results. 2° tilt will cause an asymmetrical indentation that is just noticeable, and will cause a 1 % error in hardness (9).

10.2.2 If one leg of a diagonal is noticeably longer than the other leg of the same diagonal, resulting in a deformed indentation, misalignment is probably present and should be corrected before proceeding with any measurements. See Test Method E384.

10.2.3 Leveling the specimen is facilitated if one has a leveling device.⁸

10.2.4 If the diagonal legs are unequal as described in 10.2.2 then rotate the specimen 90° and make another indentation in an untested region. If the nonsymmetrical aspect of the indentations has rotated 90° , then the specimen surface is not perpendicular to the indenter axis. If the nonsymmetrical nature of the indentation remains in the same orientation, check the indenter for misalignment or damage.

10.3 Magnitude of Test Force—A test force of 9.81 N (1 kgf) is specified. If other forces are used because of a special requirement, or due to cracking problems at 9.81 N, then the reporting procedure of 12.6 shall be used. If additional forces are used (for example to measure the indentation size effect trend), then the reporting procedure of 12.6 shall be used for each data set.

NOTE 7—“Load” and “Force” are used interchangeably in this standard.

10.4 Clean the Indenter—The indenter shall be cleaned prior to and during a test series. A cotton swab with ethanol, methanol, or isopropanol may be used. Indenting into soft copper also may help remove debris. After each change, or removal and replacement, of the indenter it is recommended that a verification be performed with a reference test block. At least two preliminary indentations should be made to ensure that the indenter is seated properly. The results of the preliminary indentations shall be disregarded.

NOTE 8—Ceramic powders or fragments from the ceramic test piece can adhere to the diamond indenter.

10.5 Application of Test Force:

10.5.1 Start the machine smoothly. The rate of indenter motion prior to contact with the specimen shall be 0.015 to 0.070 mm/s. If the machine is loaded by an electrical system or a dash-pot lever system, it should be mounted on shock absorbers that damp out all vibrations by the time the indenter touches the specimen.

NOTE 9—The rate of loading is consistent with Test Method E384.

10.5.2 The time of application of the full test force shall be 10 to 15 s unless otherwise specified. After the indenter has been in contact with the specimen from this required dwell time, raise it carefully off the specimen to avoid a vibration impact.

10.5.3 The operator shall not bump or inadvertently contact the test machine or associated support (for example, the table) during the period of indenter contact with the specimen.

10.6 Spacing of Indentations—Allow a distance of at least four diagonal lengths between the centers of the indentations as illustrated in Fig. 3. If there is cracking from the indentations, the spacing shall be increased to at least five times the length of the cracks, as shown in Fig. 3.

10.7 Acceptability of Indentations:

10.7.1 If there is excessive cracking from the indentation tips and sides, or the indentation is asymmetric, the indent shall be rejected for measurement. Fig. 4 provides guidance in this assessment. If the difference of the two diagonal lengths d_1 and d_2 is more than 5% of the mean value, the result shall be rejected and a check made of the parallelism and flatness of the test piece, and of the alignment of the indenter. If cracking

⁷ Available from National Institute of Standards and Technology (NIST), Standard Reference Materials Program, 100 Bureau Dr., Stop 2300, Gaithersburg, MD 20899-2300, <http://www.nist.gov>.

⁸ The sole source of supply of the apparatus known to the committee at this time is the Tukon Tester leveling device, available from the Wilson Division of Instron Corp. If you are aware of alternative suppliers, please provide this information to ASTM Headquarters. Your comments will receive careful consideration at a meeting of the responsible technical committee, which you may attend.

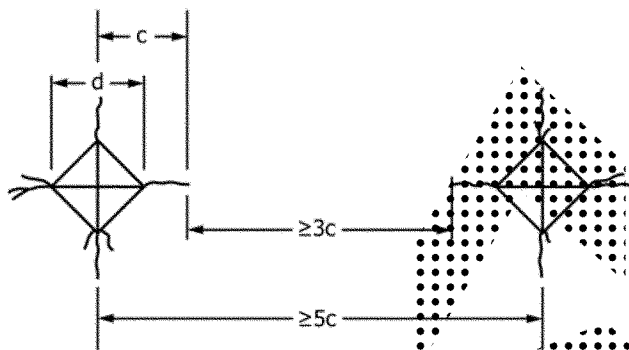
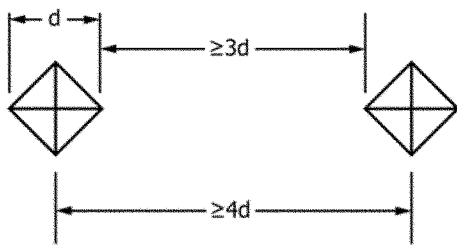

FIG. 3 Closest Permitted Spacing for Vickers Indentations

multiphase, not homogeneous, or not fully dense, ten acceptable indentations shall be made.

11. Measurement of Indentation Size

11.1 The accuracy of the test method depends to a very large extent on this measurement, since hardness depends upon the inverse square of the diagonal size.

11.1.1 If the measuring system contains a light source, take care to use the system only after it has reached equilibrium temperature. This is because the magnification of a microscope depends on the tube length.

11.1.2 Calibrate the measuring system carefully with an accurate and precision stage micrometer or with an optical grating.

11.1.3 Adjust the illumination and focusing conditions carefully as specified in Test Method E384 to obtain the optimum view and clarity of the impression. Proper focus and illumination are critical for accurate and precise readings. Both indentation tips shall be in focus at the same time. Do not change the focus once the measurement of the diagonal length has begun.

Note 12—The lighting intensity and the settings of the field and aperture diaphragms can have a noticeable effect upon the apparent location of the tips in Vickers indentations. Consult the manufacturer's guidelines for optimum procedures. Additional information is presented in Test Method E384. In general, the field diaphragm can be closed so that it barely enters or just disappears from the field of view. The aperture diaphragm can be closed in order to reduce glare and sharpen the image, but it should not be closed so much as to cause diffraction that distorts the edges of the indentation. These requirements are especially important with white or grey ceramics that may be transparent or translucent, and tip imaging may be more difficult.

Note 13—Uplift and curvature of the sides of the impressions may be substantial in impressions in advanced ceramics, which may cause the sides of the impression to be slightly out of focus. The tips of the impression shall be focused on for measurement of the indentation diagonals. It may be helpful to focus on a small microstructural feature on the flat specimen surface just beyond the indentation tips.

11.1.4 If either a measuring microscope or a filar micrometer eyepiece is used, always rotate the drum in the same direction to eliminate backlash errors.

11.1.5 Follow the manufacturer's guidelines for the use of crosshairs or graduated lines. To eliminate the influence of the thickness of the line, always use the same edge of the crosshair or graduation line. **Caution**—Serious systematic errors can occur due to improper crosshair usage. Procedures vary considerably between different equipment. In nearly all instances, the crosshairs should not be placed entirely over or fully cover the indentation tip as shown in part (a) of Fig. 5. The indentation tip should be just visible in the fringe of light on the side of the crosshair or graduated line as shown in part (b) of Fig. 5 or part (c) of Fig. 5. In some measuring systems with twin crosshairs, the measurement is made with the inside edge of the two lines as shown in part (b) of Fig. 5. In other measuring systems, particularly those with a single moveable crosshair, the measurement is made with the same side of the crosshair as shown in part (c) of Fig. 5.

11.1.6 Read the two diagonals of the indent to within 0.25 μm (0.00025) mm and determine the average of the diagonal lengths.

occurs on most indentations, a lower indentation force (recommended 4.90 N) may be used.

NOTE 10—If the indentations are still not acceptable, this test method shall not be used to measure hardness. It is recommended that hardness be evaluated by the Knoop hardness method.

10.7.2 If an indentation tip falls in a pore, the indentation shall be rejected. If the indentation lies in or on a large pore, the indent shall be rejected.

NOTE 11—In many ceramics, porosity may be small and finely distributed. The indentations will intersect some porosity. The measured hardness in such instances properly reflects a diminished hardness relative to the fully dense advanced ceramic. The intent of the restrictions in 10.6 is to rule out obviously unsatisfactory or atypical indentations for measurement purposes.

10.7.3 If the impression has an irregularity that indicates the indenter is chipped or cracked, the indent shall be rejected and the indenter shall be replaced.

10.8 In some materials, cracking around the indent may occur in a time dependent manner. If this occurs, the indentation size measurements specified in Section 11 should be made as soon as is practical after the indentation is made. That is, each indent should be measured immediately after it is made (instead of making five or ten indentations and then measuring them).

10.9 *Location of Indentations*—Indentations shall be made in representative areas of the advanced ceramic microstructure. They shall not be restricted to high density regions if such regions exist.

10.10 *Number of Indentations*—For homogeneous and fully dense advanced ceramics, at least five and preferably ten acceptable indentations shall be made. If the ceramic is

ACCEPTABLE INDENTATIONS

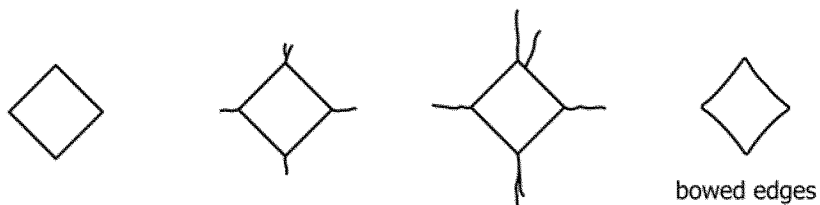

UNACCEPTABLE INDENTATIONS

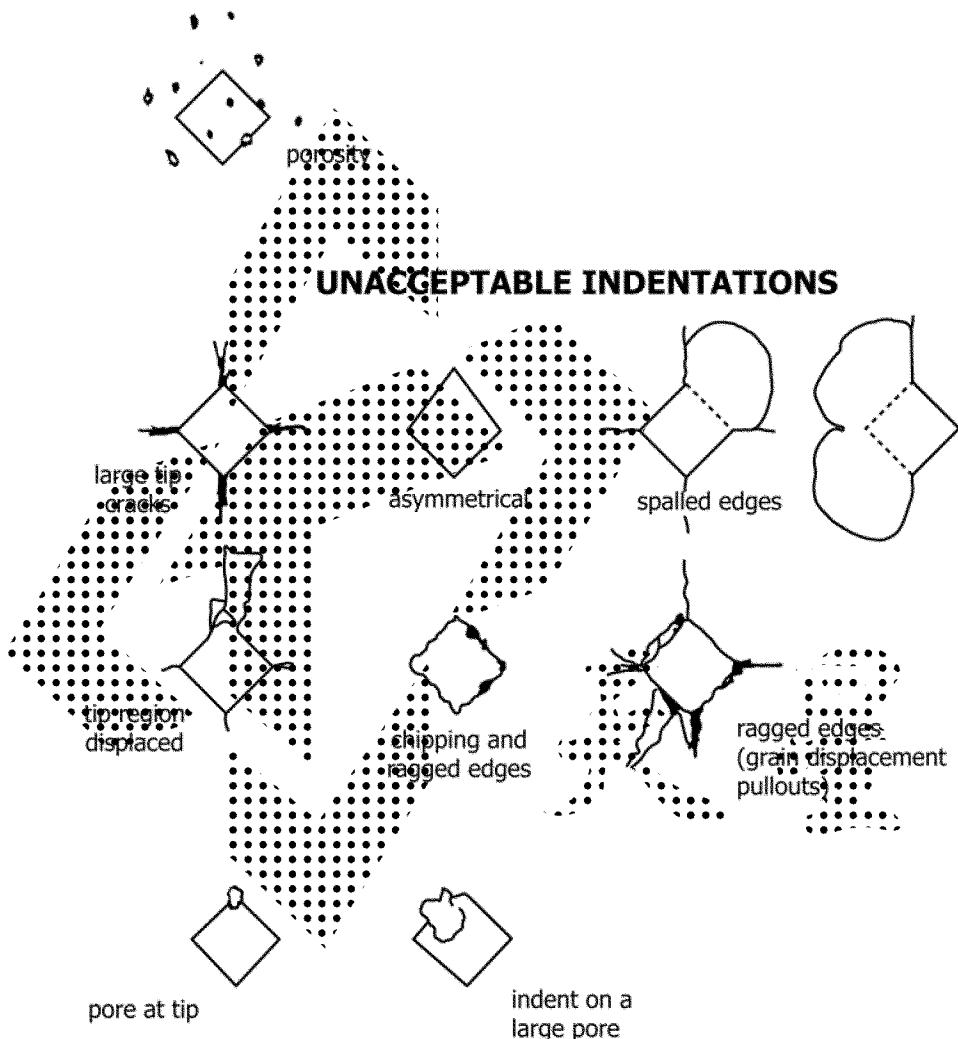

FIG. 4 Guidelines for the Acceptance of Indentations

11.1.7 Use the same filters in the light system at all times. Usually a green filter is used.

11.1.8 For transparent or translucent ceramics, where contrast is poor, the specimen may be coated (for example, a gold/palladium coating) to improve the measurability of the indents (4). Such coatings shall be less than 50 nm thick and shall be applied after the indentations have been made. Never indent into coatings made to enhance visibility.

12. Calculation

12.1 Vickers hardness may be calculated and reported either in units of GPa (12.2) or as a dimensionless Vickers hardness number (12.3).

12.2 The Vickers hardness with units of GPa is computed as follows:

$$HV = 0.0018544 (P/d^2) \tag{1}$$

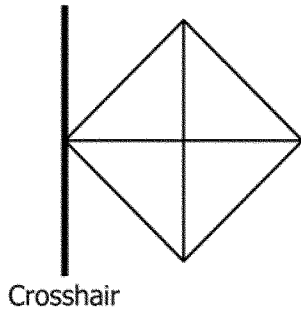

(a) INCORRECT. Crosshair completely covers the tip.

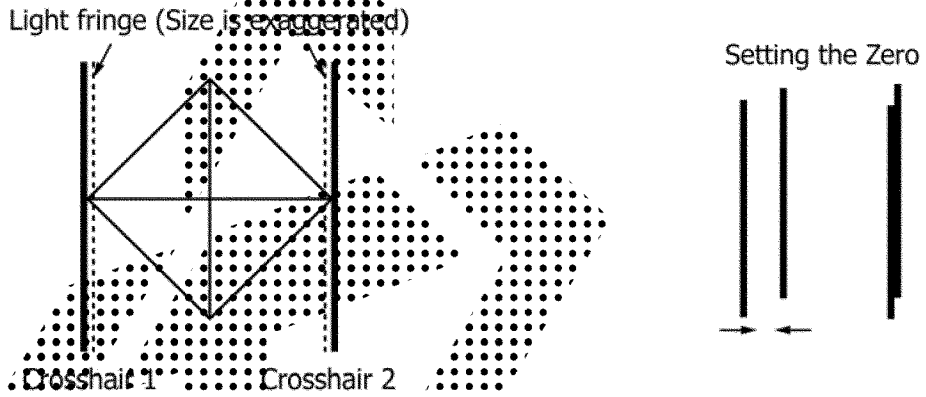

(b) CORRECT. Double crosshair measurement system, whereby the indentation is intended to be measured between two crosshairs or measuring lines. Indentation tips should be on the inside edge (in the fringe) of each crosshair. The measuring system is zeroed by bringing the inside measuring line inside edges together as shown on the right.

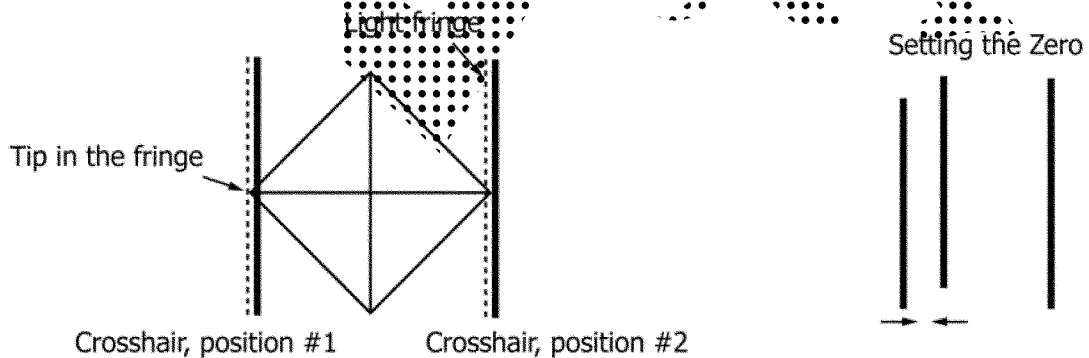

(c) CORRECT. Single crosshair and some double crosshair measurement systems. The indentation tip is on the same side of the crosshair line(s). The measuring system is zeroed with the tip on the same side of one line for a single crosshair system, or with both lines superimposed in a double crosshair system as shown on the right.

FIG. 5 Crosshair Measurement

where:

- P = force, N, and
- d = average length of the two diagonals of the indentation, mm.

NOTE 14—This computation and set of units are in accordance with the recommendations of IEEE/ASTM SI 10.

12.3 The Vickers hardness number is computed as follows:

$$HV = 1.8544 (P/d^2) \quad (2)$$

where:

- P = force, kgf, and
- d = average length of the two diagonals of the indentation, mm.

NOTE 15—This computation is consistent with Test Method E384.

Alternately, the Vickers hardness number also may be computed as follows:

$$HV = (0.102)(1.8544)(P/d^2) \quad (3)$$

where:

- P = force, N, and
- d = average length of the two diagonals of the indentation, mm.

NOTE 16—This computation is consistent with ISO 6507-2, EN 843-1, and JIS R 1610.

NOTE 17—Eq 2 and Eq 3 compute the Vickers hardness number, which is a dimensionless number; for example, $HV = 1500$. HV formerly had been assigned units of kgf/mm^2 . Eq 2 and Eq 3 produce the same Vickers hardness number.

NOTE 18—The factor 0.102 in Eq 3 becomes necessary through the introduction of the SI unit newton for the test force instead of kilogram-force to avoid changing the value of the Vickers hardness number from its traditional units.

12.4 The mean hardness, \bar{HV} , is:

$$\bar{HV} = \frac{\sum HV_n}{n} \quad (4)$$

where:

- HV_n = HV obtained from n th indentation and
- n = number of indentations.

12.5 The standard deviation, S , is:

$$S = \sqrt{\frac{\sum (\bar{HV} - HV_n)^2}{n - 1}} \quad (5)$$

12.6 The hardness symbol HV shall be supplemented by a number indicating the test force used, expressed in newtons multiplied by 0.102 (and therefore equal to the test force expressed in kilograms-force), and optionally a number indicating the duration of test force applications in seconds. So, for example, $HV1/15$ means the Vickers hardness for an applied test force of 9.81 N (1 kgf) applied for 15 s at full load.

13. Report

13.1 The report shall include the following information:

- 13.1.1 Mean HV ,
- 13.1.2 Test load,
- 13.1.3 Duration of test load,
- 13.1.4 Standard deviation,
- 13.1.5 Test temperature and humidity,
- 13.1.6 Number of satisfactory indentations measured, as well as the total number of indents made,
- 13.1.7 Surface conditions and surface preparation,

- 13.1.8 Thermal history of the sample,
- 13.1.9 The extent of cracking (if any) observed, and
- 13.1.10 Deviations from the specified procedures, if any.
- 13.1.11 Data on the indentation size effect trend if hardness is measured over a range of indentation forces.

14. Precision and Bias

14.1 The precision and bias of microhardness measurements depend on strict adherence to the stated test procedure and are influenced by instrumental and material factors and indentation measurement errors.

14.2 The consistency of agreement for repeated tests on the same material is dependent on the homogeneity of the material, repeatability and reproducibility of the hardness tester, and consistent, careful measurements of the indents by a competent operator.

14.3 Instrumental factors that can affect test results include accuracy of loading, inertia effects, speed of loading, vibrations, the angle of indentation, lateral movement of the indenter or sample, indentation, and indenter shape deviations. Results are particularly sensitive to vibration or impact, which will produce larger indents and lower apparent hardness results.

14.4 The largest source of error or uncertainty in hardness usually arises from the error and uncertainty in the measurement of the diagonal length.

14.4.1 The harder the material, the smaller the indent size is. Therefore, hardness uncertainties are usually greater for harder materials.

14.4.2 Diagonal length measurement errors include inaccurate calibration of the measuring device, inadequate resolving power of the objective, insufficient magnification, operator bias in sizing the indents, poor image quality, and nonuniform illumination. These can contribute to both bias and precision errors.

14.4.3 The numerical aperture (NA) of the objective lens determines the maximum useful magnification and the resolving power of the microscope. The higher the NA of the lens, the longer the indentation will appear. This limited resolution leads to a bias error since the microscope is not able to resolve the exact tip and thus leads to underestimates of the true length. The theoretical shortening is estimated to be $\lambda/2NA$, where λ is the wavelength of the light used (2, 5). Experimental evidence indicates that actual shortening is less than this, but the use of different NA objective lenses will contribute to a reproducibility (between-laboratory) uncertainty of less than $\pm 0.2 \mu\text{m}$ (5, 6). (This error is substantially less for Vickers indentations than for Knoop indentations.)

14.5 A round robin was conducted to evaluate the suitability of tungsten carbide-cobalt specimens as standard hardness test blocks (10, 11).⁹ The results of this eleven-laboratory round robin can be used to evaluate the precision of Vickers hardness measurements for a hard material (~ 15 GPa) that does not pose difficult measuring problems. Within-laboratory repeatability and between-laboratory reproducibility were evaluated

TABLE 1 Precision of Diagonal Length Measurements Estimated from an Interlaboratory Round Robin Project (10, 11)

Load, <i>P</i> (N)	Number of Laboratories	Grand Average Diagonal Length, <i>d</i> (μm)	Within-Laboratory Repeatability			Between-Laboratory Reproducibility		
			Standard Deviation (μm)	Expanded Uncertainty ^A (μm)	Coefficient of Variation, %	Standard Deviation (μm)	Expanded Uncertainty ^A (μm)	Coefficient of Variation, %
9.81 ^B	10	34.5	0.2	0.6	0.6	1.1	2.9	3.0
9.81 ^C	8	34.6	0.2	0.6	0.6	1.0	2.7	2.8

^A Coverage factor of 2.8, corresponding to a 95 % confidence interval.

^B Indentations made by organizing laboratory. Outlier results from one laboratory deleted.

^C Indentations made by participating laboratories. Outlier results from two laboratories deleted. One other laboratory did not do this part of the exercise.

in accordance with Practices E177 and E691. The results are listed in Table 1, which shows the repeatability and reproducibility in measured diagonal lengths when using the average diagonal size for each indentation. The hardness repeatability interval when expressed as a percentage is double the diagonal-length repeatability interval. Participants read five indentations made at 9.81 N at the organizing laboratory, and also made and measured five of their own indentations at the same force. They reported the average diagonal size for each of the five indentations and the overall average for all five indentations. Table 1 shows the grand average of all accepted laboratory results. The within-laboratory hardness repeatabilities were 1.2

and 1.3 % (coefficient of variation, COV), respectively. The between-laboratory hardness reproducibilities were 6.1 and 5.6 % (COV), respectively. The reproducibility estimates were made after deleting one or two outlier sets as noted in Table 1. The reproducibility uncertainty includes both the hardness measurement uncertainty and the variations in hardness (± 2.8 %, COV) of the eight blocks used in the round robin.

15. Keywords

advanced ceramics; cracks; indentation; microscope; Vickers hardness

APPENDIX

(Nonmandatory Information)

X1. REVISION HISTORY

X1.1 This standard was originally adopted in February 1996 as C1327-96.

X1.2 In late 1996, revisions were made including a recommendation that gold coatings not be applied before making indentations, new guidance on how to inspect the Vickers indenter for damage, and new guidance on how to use crosshairs on the optical microscope when measuring indentation sizes. The revised standard was designated C1327-96a.

X1.3 In 1999, a revision was made to the definition of “Vickers hardness number.” The old definition explicitly stated it was with kilograms force. The new definition was more generic and deleted mention of kilograms force and millimetres. This change matched a similar change in Test Method E384. A definition of a “Vickers indenter” was also added. The revised standard was designated C1327-99.

X1.4 In 2003, four revisions were made including: a change of the lower limit of the compound optical microscope numerical aperture limit from 0.65 to 0.60; addition of information about the indentation size effect; addition of limits of asymmetry of an indentation; and editorial changes such as changing the word “load” to “force.” The revised standard was designated C1327-03.

X1.5 In 2008, two new columns of data were added to Table 1 for the interlaboratory round robin project results. The new columns listed the standard deviation values for the repeatability and reproducibility of the diagonal length measurements. The revised standard was designated C1327-08.

X1.6 In 2015, changes were made including: minor adjustments to harmonize this test method with the newly revised Test Method E384; additions to the Scope section to better explain this test method and also the history of the units in use; conversion of a few more “load” to “force” terms; more guidance on inspecting diamond indenters in 7.2.3; more guidance on digital cameras for measuring diagonal sizes in 7.3.4; more guidance on asymmetric indentations in 10.2.4; and a small but important clarification in the fourth sentence of 14.5 that the repeatability and reproducibility uncertainties in Table 1 are for the average diagonal size for a single indentation computed from the two diagonal. One major change is the addition of a new Fig. 1 showing a schematic of the indentation size effect curve. Another major change is an expansion of the types of hardness machines from two to three possible types in 7.1 to include modern machines with load cells and closed loop feedback control of the force application cycle. The revised standard was designated C1327-15.

REFERENCES

- (1) Small, L., *Hardness Theory and Practice (Part I: Practice)*, Service Diamond Tool Co., Ann Arbor, MI, 1960, pp. 241–243.
- (2) Mott, B. W., *Micro-Indentation Hardness Testing*, Butterworth's Scientific Publications, London, 1956.
- (3) Blau, P. J., "Methods and Applications of Microindentation Hardness Testing," *Applied Metallography*, Vander Voort, G. F., ed., Van Nostrand-Reinhold, 1986, pp. 123–138.
- (4) Clinton, D. J., and Morrell, R., "Hardness Testing of Ceramic Materials," *Material Chemistry and Physics*, Vol 17, 1987, pp. 461–473.
- (5) Brown, A. R. G., and Ineson, E., "Experimental Survey of Low-Load Hardness Testing Machines," *Journal of Iron and Steel Institute*, Vol 169, 1951, pp. 376–388.
- (6) Gahn, J., "Neurere Erkinntnisse zur Mikro-Härte," (New Results on Microhardness), Verein Deutscher Ingenieure Berichte, *Society of German Engineers, Reports*, Nr 160, 1972, pp. 25–41.
- (7) Naylor, M. G. S., and Page, T. F., "Microhardness, Friction and Wear of SiC and Si₃N₄ Materials as a Function of Load, Temperature and Environment," Third Annual Technical Report, October 1981, Cambridge University, England.
- (8) Thibault, N. W., and Nyquist, H. L., "The Measured Hardness of Hard Substances and Factors Affecting Its Determination," *Transactions of the American Society of Metals*, Vol 38, 1947, pp. 271–330.
- (9) Mulhearn, T. O., and Samuels, L. E., "The Errors Introduced into Diamond Pyramid Hardness Testing by Tilting the Specimen," *Journal of Iron and Steel Institute*, August 1955, pp.354–359.
- (10) Quinn, G. D., Gettings, R. J., and Ives, L. K., "A Standard Reference Materials for Vickers Hardness of Ceramics and Hardmetals," pp. 121– 128 in proceedings of *HARDMEKO 2004, Hardness Measurements Theory and Application in Laboratories and Industries*, IMEKO Technical Committee 5 Hardness Conference, Washington, DC, 11 – 12 Nov. 2004, ed. S. Low, NIST, Gaithersburg, MD 20899.
- (11) Gettings, R. J., Quinn, G. D., Ruff, A. W., and Ives, L. K., "Hardness Standard Reference Materials (SRM) for Advanced Ceramics," *Verein Deutscher Ingenieure Reports*, 1194, 1995, pp. 255–264.

ASTM International takes no position respecting the validity of any patent rights asserted in connection with any item mentioned in this standard. Users of this standard are expressly advised that determination of the validity of any such patent rights, and the risk of infringement of such rights, are entirely their own responsibility.

This standard is subject to revision at any time by the responsible technical committee and must be reviewed every five years and if not revised, either reapproved or withdrawn. Your comments are invited either for revision of this standard or for additional standards and should be addressed to ASTM International Headquarters. Your comments will receive careful consideration at a meeting of the responsible technical committee, which you may attend. If you feel that your comments have not received a fair hearing you should make your views known to the ASTM Committee on Standards, at the address shown below.

This standard is copyrighted by ASTM International, 100 Barr Harbor Drive, PO Box C700, West Conshohocken, PA 19428-2959, United States. Individual reprints (single or multiple copies) of this standard may be obtained by contacting ASTM at the above address or at 610-832-9585 (phone), 610-832-9555 (fax), or service@astm.org (e-mail); or through the ASTM website (www.astm.org). Permission rights to photocopy the standard may also be secured from the Copyright Clearance Center, 222 Rosewood Drive, Danvers, MA 01923. Tel: (978) 646-2600; <http://www.copyright.com/>